

# Hydro Multi-E

Installation and operating instructions

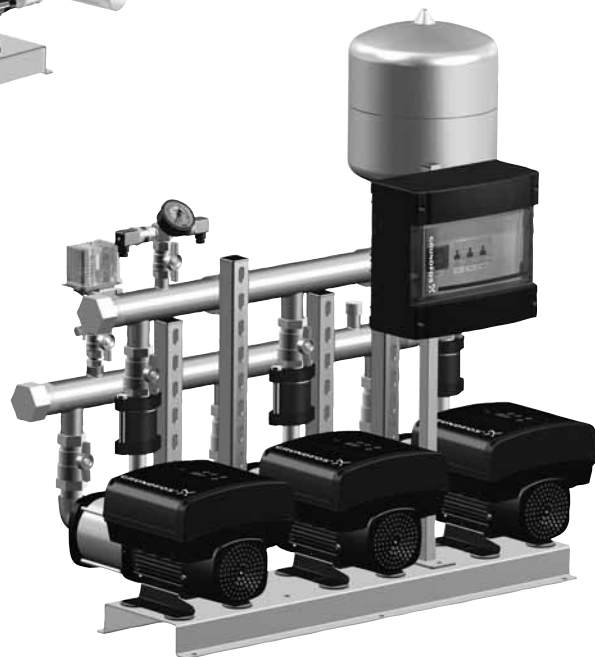
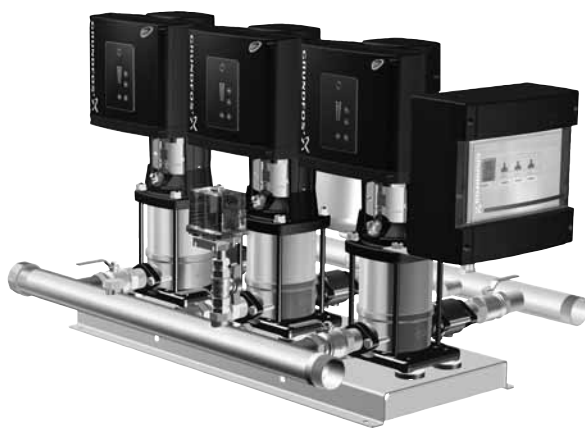

## English (GB) Installation and operating instructions

**Original installation and operating instructions**

These installation and operation instructions apply to the Grundfos Hydro Multi-E booster systems.

**CONTENTS**

	Page		Page
<b>1. Symbols used in this document</b>	<b>2</b>	<b>23. Shutdown</b>	<b>19</b>
1.1 Warnings against hazards involving risk of death or personal injury	2	23.1 Frost protection	19
1.2 Other important notes	2	23.2 Service kits	19
<b>2. Scope of these instructions</b>	<b>3</b>	<b>24. Fault finding</b>	<b>20</b>
<b>3. System sizing</b>	<b>3</b>	<b>25. Technical data, Hydro Multi-E with single-phase pumps</b>	<b>21</b>
<b>4. Product description</b>	<b>3</b>	25.1 Supply voltage	21
4.1 General description	3	25.2 Leakage current	21
4.2 Functions	3	<b>26. Technical data, Hydro Multi-E with three-phase pumps</b>	<b>21</b>
4.3 Hydro Multi-E	3	26.1 Supply voltage	21
<b>5. Identification</b>	<b>3</b>	26.2 Leakage current	21
5.1 Nameplate	3	<b>27. Inputs and outputs</b>	<b>21</b>
<b>6. Type key</b>	<b>4</b>	<b>28. Other technical data</b>	<b>22</b>
<b>7. Operating conditions</b>	<b>5</b>	<b>29. Sound pressure level</b>	<b>22</b>
7.1 Temperatures	5	29.1 Hydro Multi-E with single-phase pumps	22
7.2 Installation altitude	5	29.2 Hydro Multi-E with three-phase pumps	22
7.3 Relative humidity	5	<b>30. Disposal</b>	<b>22</b>
7.4 Maximum operating pressure	5		
7.5 Shaft seal run-in	5		
7.6 Minimum inlet pressure	5		
7.7 Maximum inlet pressure	6		
7.8 Minimum flow rate	6		
7.9 Start and stop	6		
7.10 Diaphragm tank	6		
<b>8. Installation</b>	<b>6</b>		
8.1 Location	6		
8.2 Mechanical installation	6		
8.3 Electrical installation	7		
8.4 Mains supply	7		
8.5 Additional protection	8		
<b>9. Startup</b>	<b>8</b>		
9.1 Hydro Multi-E in system with positive inlet pressure	8		
9.2 Hydro Multi-E in system without inlet pressure	9		
<b>10. Operating modes</b>	<b>10</b>		
10.1 Normal operation	10		
10.2 Stop or Max. operation	10		
10.3 Operating condition in case of disconnection of power supply	10		
10.4 Further settings	10		
<b>11. User interfaces</b>	<b>10</b>		
11.1 Standard control panel	10		
<b>12. Grundfos GO Remote</b>	<b>12</b>		
12.1 Communication	12		
12.2 Menu overview for Grundfos GO Remote	13		
<b>13. Multi-master function</b>	<b>14</b>		
13.1 Systems with one outlet-pressure sensor	14		
13.2 Systems with two or more outlet-pressure sensors	14		
<b>14. Protective functions</b>	<b>14</b>		
14.1 Dry-running protection	14		
<b>15. Bus signal</b>	<b>16</b>		
<b>16. Priority of settings</b>	<b>16</b>		
<b>17. Grundfos Eye</b>	<b>17</b>		
<b>18. Signal relays</b>	<b>18</b>		
<b>19. Digital input</b>	<b>19</b>		
<b>20. Data communication</b>	<b>19</b>		
<b>21. Insulation resistance</b>	<b>19</b>		
<b>22. Maintenance</b>	<b>19</b>		
22.1 Pumps	19		
22.2 Motors	19		
22.3 Breaker cabinet	19		



Prior to installation, read this document. Installation and operation must comply with local regulations and accepted codes of good practice.

**1. Symbols used in this document****1.1 Warnings against hazards involving risk of death or personal injury****DANGER**

Indicates a hazardous situation which, if not avoided, will result in death or serious personal injury.

**WARNING**

Indicates a hazardous situation which, if not avoided, could result in death or serious personal injury.

**CAUTION**

Indicates a hazardous situation which, if not avoided, could result in minor or moderate personal injury.

The text accompanying the three hazard symbols DANGER, WARNING and CAUTION is structured in the following way:

**SIGNAL WORD****Description of hazard**

Consequence of ignoring the warning.  
- Action to avoid the hazard.

**1.2 Other important notes**

A blue or grey circle with a white graphical symbol indicates that an action must be taken.



A red or grey circle with a diagonal bar, possibly with a black graphical symbol, indicates that an action must not be taken or must be stopped.



If these instructions are not observed, it may result in malfunction or damage to the equipment.



Tips and advice that make the work easier.

## 2. Scope of these instructions

These installation and operating instructions apply to the Grundfos Hydro Multi-E booster systems.

Hydro Multi-E is a range of factory-assembled booster systems, ready for installation and operation.

## 3. System sizing



The system in which Hydro Multi-E is incorporated must be designed for the maximum pump pressure.

## 4. Product description

### 4.1 General description

The Grundfos Hydro Multi-E booster systems are designed for pressure boosting of clean water in blocks of flats, hotels, hospitals, schools, etc.

Hydro Multi-E incorporates Grundfos CRE, CRIE, CME-A or CME-I pumps with integrated frequency-controlled single- or three-phase MGE motors and a breaker cabinet.

The system maintains a constant pressure through continuous variable adjustment of the speed of the pumps connected.

The system adjusts its performance to the demand by cutting the required number of pumps in or out and by parallel control of the pumps in operation.

The system has been factory-assembled and tested with the control parameters mentioned in the quick guide supplied with the booster system.

### 4.2 Functions

Hydro Multi-E offers the following functions:

- multi-master function
- constant pressure
- redundant sensor
- stop at low flow
- cascade control of pumps
- automatic alternation
- pipe filling
- limit-exceeded function
- two digital inputs
- two digital outputs
- two analog inputs
- optional bus communication via Grundfos CIM modules.

## 4.3 Hydro Multi-E

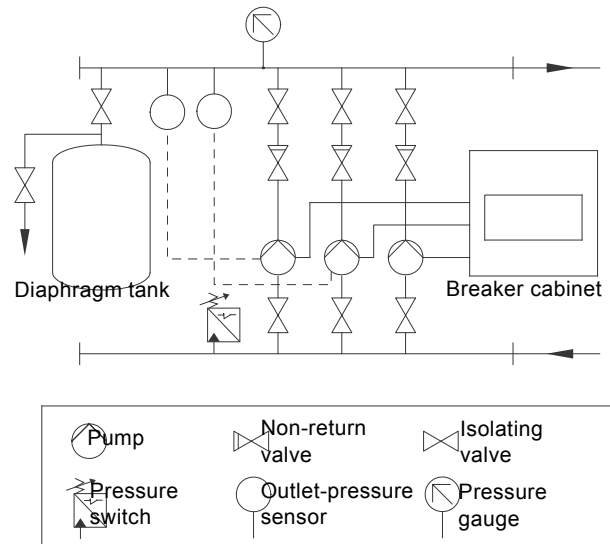

Fig. 1 Hydro Multi-E components

The breaker cabinet incorporates a main switch and circuit breakers.

## 5. Identification

### 5.1 Nameplate

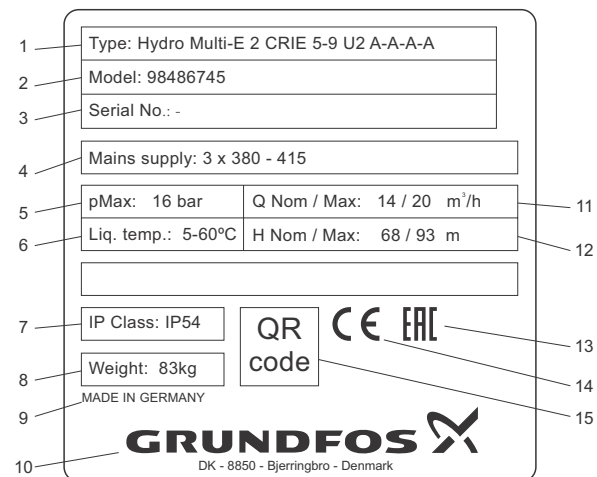

Fig. 2 Hydro Multi-E nameplate

Pos.	Description
1	Type designation
2	Model
3	Serial number
4	Supply voltage
5	Maximum operating pressure in bar
6	Liquid temperature
7	Enclosure class
8	Weight in kg
9	Country of origin
10	Company logo
11	Maximum flow rate in m <sup>3</sup> /h
12	Nominal head in metres
13	Approval mark
14	Approval mark
15	QR code

TM02 4280 1902

TM06 7460 3516

## 6. Type key

Example	Hydro Multi	-E	2	CRIE 15-3	U7	A-	A-	A-	A-	ABCDEF
<b>Name</b>										
<b>System type</b> E: All pumps with E-motor										
<b>Number of main pumps</b>										
<b>Pump type</b>										
<b>Voltage code</b> U1: 3 x 380-415, N, PE, 50/60 Hz (three phase system with single-phase pumps) U2: 3 x 380-415, PE, 50/60 Hz U7: 1 x 200-240, PE, 50/60 Hz U8: 1 x 200-240, N, PE, 50/60 Hz UX: CSU variant (special voltage rating)										
<b>Design</b> A: Systems with breaker cabinet mounted on the system B: Systems with wall mounted breaker cabinet and 5 m power supply cable C: Systems with breaker cabinet mounted on the left side.										
<b>Starting method</b> A: E, variable frequency, VFD										
<b>Material combination</b> A: Stainless steel manifold, base frame and standard valves B: Stainless steel manifold, base frame and valves C: Galvanised steel manifold, base frame and standard valves (CME-A pumps only) G: Galvanised steel manifold, base frame and standard valves P: Stainless steel manifold, galvanised steel base frame and standard valves										
<b>Drinking water approvals</b> A: ACS-approved components B: Belgaqua-approved components D: DVGW-approved components K: KIWA-approved components N: NFS-approved components V: WRAS-approved components W: WRAS-approved system Y: No special approval										
<b>Options</b> A: Standard hydraulics B: No redundant outlet-pressure sensor C: Outlet-pressure sensor on each pump D: Sensor as dry-running protection E: No dry-running protection F: Level switch as dry-running protection G: CIM module included K: No inlet manifold L: Non-return valves on the inlet side S: CSU variant U: Undersized motor X: More than four options										

## 7. Operating conditions

### 7.1 Temperatures

#### 7.1.1 Ambient temperature during storage and transportation

Minimum -30 °C

Maximum +60 °C.

#### 7.1.2 Ambient temperature during operation

Minimum -20 °C

Maximum +50 °C.

The motors can operate with the rated output power (P2) at 50 °C, but continuous operation at higher temperatures will reduce the expected product life. If the motors are to operate at ambient temperatures between 50 and 60 °C, oversized motors must be selected. Contact Grundfos for further information.

#### 7.1.3 Liquid temperature

0 to +60 °C.

### 7.2 Installation altitude



Do not install the motors more than 2000 metres above sea level.

Installation altitude is the height above sea level of the installation site.

- Motors installed up to 1000 metres above sea level can be loaded 100 %.
- Motors installed more than 1000 metres above sea level must not be fully loaded due to the low density and consequent low cooling effect of the air. See fig. 3.

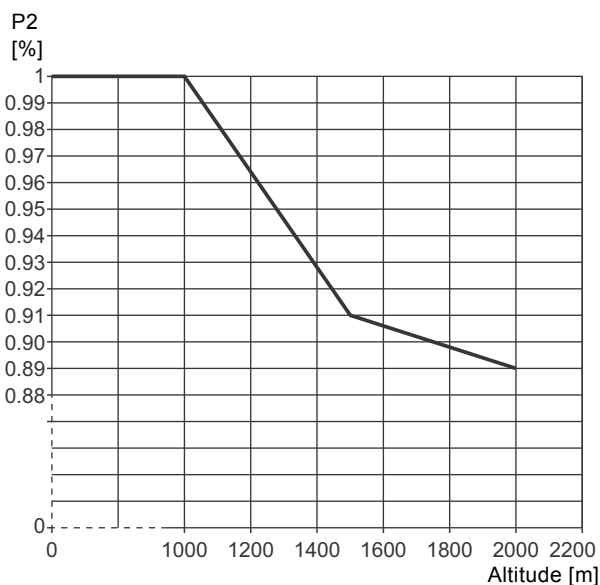

Fig. 3 Derating of motor output power (P2) in relation to altitude above sea level

TM05 6400 4712

### 7.3 Relative humidity

Maximum 95 %.

### 7.4 Maximum operating pressure

See system nameplate.

### 7.5 Shaft seal run-in

The seal faces are lubricated by the pumped liquid, meaning that there may be a certain amount of leakage from the shaft seal.

When the pump is started up for the first time, or when a new shaft seal is installed, a certain run-in period is required before the leakage is reduced to an acceptable level. The time required for this depends on the operating conditions, that is every time the operating conditions change, a new run-in period will be started.

Under normal conditions, the leaking liquid evaporates. As a result, a leakage will not be detected.

### 7.6 Minimum inlet pressure

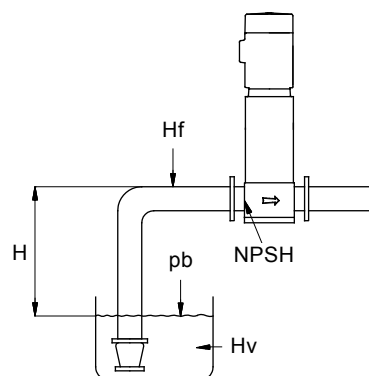

Fig. 4 Parameters for the calculation of minimum inlet pressure

TM02 0118 3800

The minimum inlet pressure "H" in metres head required to avoid cavitation in the pumps can be calculated as follows:

#### Hydro Multi-E with CME pumps

$$H = pb \times 10.2 - NPSH - H_f - H_v - H_s$$

pb = Barometric pressure in bar. Barometric pressure can be set to 1 bar.

In closed systems, pb indicates the system pressure in bar.

NPSH = Net Positive Suction Head in metres head

The NPSH value can be read from the NPSH curve at the highest flow which the individual pump will be delivering.

Hf = Friction loss in inlet manifold in metres head at the highest flow the individual pump will be delivering.

**Note:** If a non-return valve is installed on the inlet side of the pump, the friction loss in the valve must be added. See the manufacturer's data.

Hv = Vapour pressure in metres head.

Hs = Safety margin of min. 0.5 metres head.

Hydro Multi-E systems with CME pumps always require a positive inlet pressure, both during startup and operation.



In some regions, the booster system is available with a low inlet manifold which makes it more suitable for suction lift operation. Contact Grundfos for further information.

**Example**

pb	= 1 bar.
Pump type	= CRE 15, 50 Hz.
Flow rate	= 15 m <sup>3</sup> /h
NPSH	
(from page 23)	= 1.2 metres head.
Hf	= 3.0 metres head.
Liquid temperature	= +60 °C.
Hv	
(from page 24)	= 2.1 metres head.
H	= pb x 10.2 - NPSH - Hf - Hv - Hs [metres head].
H	= 1 x 10.2 - 1.2 - 3.0 - 2.1 - 0.5 equal to 2.8 metres head.

This means that each pump can operate at a suction lift of maximum 2.8 metres head.

Pressure calculated in bar:  $2.8 \times 0.0981$  equal to 0.27.

Pressure calculated in kPa:  $2.8 \times 9.81$  equal to 27.4.

**7.7 Maximum inlet pressure**

The maximum inlet pressure must not exceed 8 bar. However, the actual inlet pressure plus pressure when the pump is operating against a closed valve must always be lower than the maximum operating pressure.

**7.8 Minimum flow rate**

Due to the risk of overheating, the pumps should not be used at flow rates below 10 % of the rated flow rate of one pump.



The pumps must not run against a closed outlet valve.

**7.9 Start and stop**

The system must not be started and stopped via the power supply more than four times per hour.

When the system is switched on via the power supply, it will start after approx. 5 seconds.

**7.10 Diaphragm tank**

The diaphragm tank precharge pressure must be set to 0.7 x setpoint.

If the setpoint is changed, the diaphragm tank precharge pressure should be changed accordingly to ensure optimum operation.



Measure the precharge pressure while the system is pressureless.

We recommend that you use nitrogen gas for precharging.

**8. Installation****8.1 Location**

Observe the following to ensure adequate cooling of motor and electronics:

- Position Hydro Multi-E in such a way that adequate cooling is ensured.
- Keep motor cooling fins and fan blades clean.

Hydro Multi-E is not suitable for outdoor installation.

The booster system must have a 1-metre clearance in front and on the two sides.

**8.2 Mechanical installation**

Arrows on the pump base show the direction of flow of water through the pump.

The pipes connected to the booster system must be of adequate size. Fit expansion joints in the inlet and outlet pipes to avoid resonance. See fig. 5.

Connect the pipes to the manifolds of the booster system.

The manifold comes with a screw cap fitted to one end. If this end is to be used, remove the screw cap, apply sealing compound to the other end of the manifold, and fit the screw. Fit a blanking flange with gasket on flanged manifolds.

Tighten up the booster system prior to startup.

If booster systems are installed in blocks of flats or the first consumer on the line is close to the booster system, we recommend that you fit pipe hangers on the inlet and outlet pipes to prevent vibration being transmitted through the pipes. See fig. 5.

Position the booster system on a plane and solid surface, for example a concrete floor or foundation. If the booster system is not fitted with vibration dampers, it must be bolted to the floor or the foundation.

Fasten the pipes to parts of the building to ensure that they cannot move or be twisted.

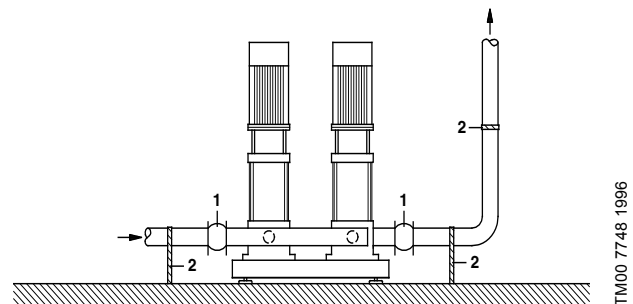

TM00 7748 1996

**Fig. 5** Installation example with expansion joints and pipe supports

Pos.	Description
1	Expansion joint
2	Pipe supports

The expansion joints and pipe supports shown in fig. 5 are not included in the standard booster system.

### 8.3 Electrical installation

Carry out the electrical connection according to local regulations. Check that the supply voltage and frequency correspond to the values stated on the nameplate.

#### DANGER

##### Electric shock

Death or serious personal injury



- Switch off the power supply and wait at least five minutes before you make any connections in the breaker cabinet or terminal boxes. Make sure that the power supply cannot be accidentally switched on.
- Connect the motor to protective earth and protect against indirect contact according to local regulations.

If the power supply cable is damaged, it must be replaced by the manufacturer, the manufacturer's service partner or a similarly qualified person.

The user or the installer is responsible for the installation of correct earthing and protection according to local regulations. All operations must be carried out by a qualified electrician.

The booster system must be stationary and installed permanently. Furthermore, connect the booster system permanently to the power supply.

Carry out the earth connection as duplicate conductors.

If the system cannot be installed with the supply disconnecting device located minimum 0.6 m above service level according to EN 60204-1 paragraph 5.3.4, install the system with an external "supply disconnecting device" made according to EN 60204-1, paragraph 5.3.2. The system must be provided with a means permitting it to be locked in OFF (isolated) position.

#### 8.3.1 Protection against electric shock, indirect contact

#### WARNING

##### Electric shock

Death or serious personal injury



- Connect the motor to protective earth and protect against indirect contact according to local regulations.

Protective-earth conductors must always have a yellow and green (PE) or yellow, green and blue (PEN) colour marking.

#### Protection against mains voltage transients

The motor is protected against mains voltage transients in accordance with EN 61800-3.

#### Motor protection

The motor requires no external motor protection. The motor incorporates thermal protection against slow overloading and blocking.

### 8.4 Mains supply

Check that the supply voltage and frequency correspond to the values stated on the nameplate.



Use dedicated IT network motors if the booster system is supplied through an IT network. Contact Grundfos.

The wires in the breaker cabinet must be as short as possible. Excepted from this is the separated earth conductor which must be so long that it is the last one to be disconnected in case the cable is inadvertently pulled out of the cable entry.

For maximum backup fuse, see section [25.1 Supply voltage](#).

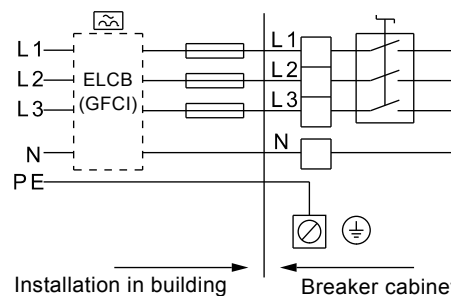

TM02 4547 4211

**Fig. 6** Example of a mains-connected Hydro Multi-E with backup fuses and additional protection (applies only for systems with single-phase motors)

For maximum backup fuse, see section [26.1 Supply voltage](#).

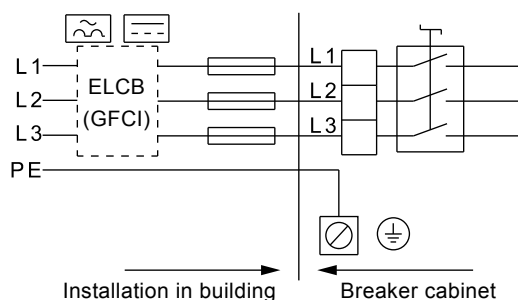

TM02 4546 4211

**Fig. 7** Example of a mains-connected Hydro Multi-E with backup fuses and additional protection (applies only for systems with three-phase motors)

## 8.5 Additional protection

### 8.5.1 Systems with single-phase motors

If Hydro Multi-E is connected to an electric installation where an earth leakage circuit breaker (ELCB) or ground fault circuit interrupter (GFCI) is used as additional protection, this circuit breaker or interrupter must be marked with the following symbol:

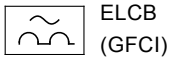

ELCB  
(GFCI)



When an earth leakage circuit breaker or ground fault circuit interrupter is selected, the total leakage current of all the electrical equipment in the installation must be taken into account.

The leakage current of Hydro Multi-E can be found in section [25.2 Leakage current](#).

### 8.5.2 Systems with three-phase motors

If Hydro Multi-E is connected to an electric installation where an earth leakage circuit breaker (ELCB) or ground fault circuit interrupter (GFCI) is used as additional protection, this circuit breaker or interrupter must be of the following type:

- It must be suitable for handling leakage currents and cutting-in with short pulse-shaped leakage.
- It must trip when alternating fault currents and fault currents with DC content, i.e. pulsating DC and smooth DC fault currents, occur.

For these systems an earth leakage circuit breaker or ground fault circuit interrupter, type B, must be used.

This circuit breaker or interrupter must be marked with the following symbols:

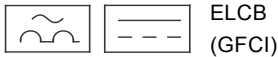

ELCB  
(GFCI)



When an earth leakage circuit breaker or ground fault circuit interrupter is selected, the total leakage current of all the electrical equipment in the installation must be taken into account.

The leakage current of Hydro Multi-E can be found in section [26.2 Leakage current](#).

### Protection against phase unbalance

The motors must be connected to a power supply with a quality corresponding to IEC 60146-1-1, class C, to ensure correct motor operation at phase unbalance.

This also ensures long life of the components.

## 9. Startup



Do not start the pumps until they have been filled with liquid.

### 9.1 Hydro Multi-E in system with positive inlet pressure

When you have carried out the mechanical and electrical installation described in section [8. Installation](#), proceed as follows:

1. Check that Hydro Multi-E corresponds to order and that no single parts have been damaged.
2. Switch off the power supply with the main switch.
3. Switch off the circuit breakers of all pumps.
4. Check that the precharge pressure in the diaphragm tank is 0.7 times the required outlet pressure (setpoint).



Measure the precharge pressure while the system is pressureless.

5. Connect water and power supplies to the system.
6. Open all pump inlet and outlet valves.
7. Vent all pumps by means of the vent screws.

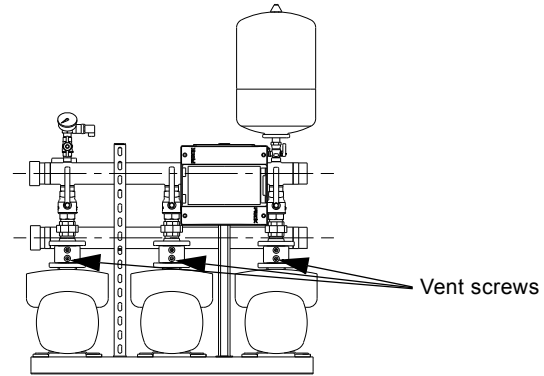

**Fig. 8** Position of vent screws in systems with CME-A/-I pumps



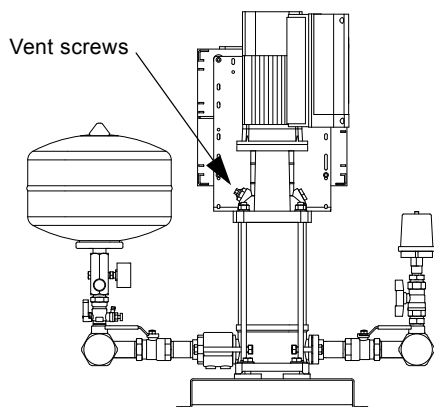

TM05 2009 1717

**Fig. 9** Position of vent screws in systems with CR(I)E pumps

8. Switch on the power supply with the main switch.
9. Start pump 1 by pressing the start/stop button on the pump control panel.
10. Vent pump 1 by means of the vent screw.
11. Repeat steps 9 and 10 for the other pumps in the system.
12. Set the desired outlet pressure.



If you change the outlet pressure, change the diaphragm tank precharge pressure accordingly.

13. Check that the pumps are cutting in and out, thus adjusting the performance to the demand.
- Hydro Multi-E is now in automatic mode and ready for operation.

## 9.2 Hydro Multi-E in system without inlet pressure



Hydro Multi-E systems with CME pumps require a positive inlet pressure during startup and operation. The following startup procedure therefore only applies to Hydro Multi-E systems with CRE or CRIE pumps.

When you have carried out the mechanical and electrical installation described in section [8. Installation](#), proceed as follows:

1. Check that Hydro Multi-E corresponds to order and that no single parts have been damaged.
2. Switch off the power supply with the main switch.
3. Switch off the circuit breakers of all pumps.
4. Check that the precharge pressure in the diaphragm tank is 0.7 times the required outlet pressure (setpoint).



Measure the precharge pressure while the system is pressureless.

5. Connect water and power supplies to the system.
6. Open all pump inlet valves.
7. Close all pump outlet valves, and prime all pumps and the inlet pipe.

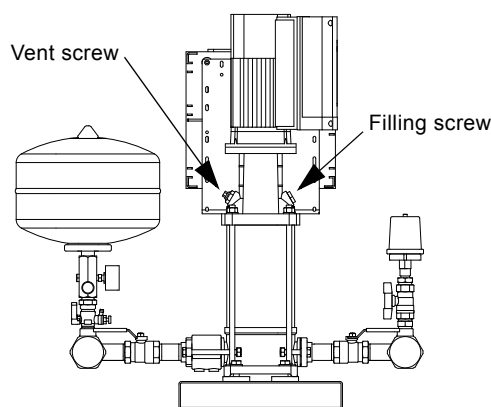

TM05 2009 1717

**Fig. 10** Position of vent screw and filling screw

8. Switch on the power supply with the main switch.
9. Start pump 1 by pressing the start/stop button on the pump control panel.
10. Vent pump 1 by means of the vent screw.
11. Slowly open the outlet valve approximately 50 %.
12. Repeat steps 9 and 11 for the other pumps in the system.
13. Slowly fully open all pump outlet valves.
14. Wait for a few minutes.
15. Set the desired outlet pressure.



If you change the outlet pressure, change the diaphragm tank precharge pressure accordingly.

16. Check that the pumps are cutting in and out, thus adjusting the performance to the demand.
- Hydro Multi-E is now in automatic mode and ready for operation.

## 10. Operating modes

The operating modes are the operating conditions that the booster system can be brought in by the user.

Possible operating modes:

- Stop  
All pumps stopped.
- Normal (factory setting)  
One or more pumps are operating to maintain the set pressure.
- Max.  
All pumps running at maximum speed.

The operating modes can be selected on the control panel, with Grundfos GO Remote or via bus.

### 10.1 Normal operation

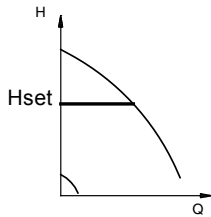

Fig. 11 Hydro Multi-E in normal operation, i.e. constant-pressure mode

In constant-pressure mode, Hydro Multi-E adjusts its performance to the desired setpoint.

### 10.2 Stop or Max. operation

In addition to normal operating mode, you can select the operating mode "Stop" or "Max.". See the example in fig. 12.

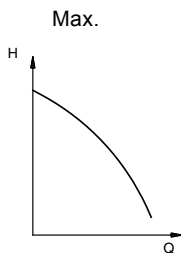

Fig. 12 Hydro Multi-E in operating mode "Max."

Max. operation can for instance be used in connection with the venting and startup procedures.

### 10.3 Operating condition in case of disconnection of power supply

If the power supply to Hydro Multi-E is disconnected, the settings will be stored. The Hydro Multi-E will restart in the same operating condition as it was in before the disconnection.

### 10.4 Further settings

You can make further settings with Grundfos GO Remote. See section 12. [Grundfos GO Remote](#).

## 11. User interfaces



### WARNING

#### Hot surface

Death or serious personal injury

- Only touch the buttons on the display as the product may be very hot.

Settings can be made by means of the following user interfaces:

- Standard control panel.  
See section 11.1 [Standard control panel](#).
- Grundfos GO Remote.  
See section 12. [Grundfos GO Remote](#).

If the power supply is switched off, the settings will be stored.

### 11.1 Standard control panel

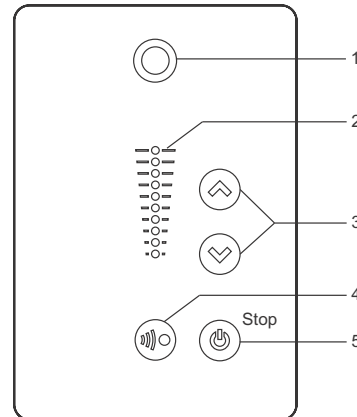

Fig. 13 Standard control panel

Pos.	Symbol	Description
1		Grundfos Eye Shows the operating status of the individual pump. See section 17. <a href="#">Grundfos Eye</a> for further information.
2	-	Light fields for indication of setpoint.
3		Changes the setpoint and resets alarms and warnings.
4		Enables radio communication with Grundfos GO Remote and other products of the same type.
		Makes the pump ready for operation or starts and stops the pump. <b>Start:</b> If the button is pressed when the pump is stopped, the pump will only start if no other functions with higher priority have been enabled. See section 16. <a href="#">Priority of settings</a> .
5		<b>Stop:</b> If the button is pressed when the pump is running, the pump will always be stopped. When the pump is stopped via this button, the "Stop" text next to the button will illuminate.

TM02 4328 0602

TM02 4318 0602

TM05 4848 3512

### 11.1.1 Setpoint setting

Set the desired setpoint by pressing  $\odot$  or  $\ominus$ . The setpoint can be set on any of the pumps in the system and applies to the complete booster system.

The light fields on the control panel will indicate the setpoint set.

#### Pump in constant-pressure control mode

The following example applies to a pump in an application where a pressure sensor gives a feedback to the pump. If the sensor is retrofitted to the pump, it must be set manually as the pump does not automatically register a connected sensor.

Figure 14 shows that the light fields 5 and 6 are activated, indicating a desired setpoint of 3 bar with a sensor measuring range from 0 to 6 bar. The setting range is equal to the sensor measuring range.

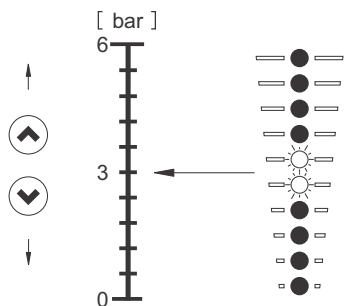

TM05 4894 3512

Fig. 14 Setpoint set to 3 bar, constant-pressure control mode

#### Pump in constant-curve control mode

In constant-curve control mode, the pump performance will lie between the maximum and minimum curve of the pump. See fig. 15.

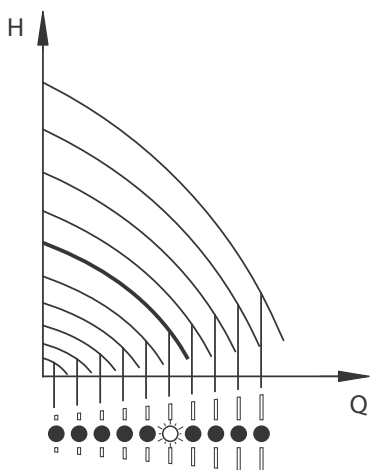

TM05 4895 2812

Fig. 15 Pump in constant-curve control mode

Setting to maximum curve:

- Press  $\odot$  continuously to change over to the maximum curve of the pump (top light field flashes). When the top light field is on, press  $\odot$  for 3 seconds until the light field starts flashing.
- To change back, press  $\ominus$  continuously until the desired setpoint is indicated.

**Example:** Pump set to maximum curve.

Figure 16 shows that the top light field is flashing, indicating maximum curve.

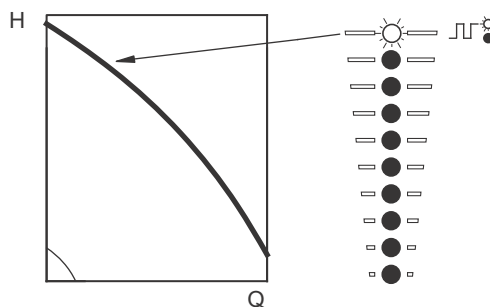

TM05 4896 2812

Fig. 16 Maximum curve duty

Setting to minimum curve:

- Press  $\ominus$  continuously to change over to the minimum curve of the pump (bottom light field flashes). When the bottom light field is on, press  $\ominus$  for 3 seconds until the light field starts flashing.
- To change back, press  $\odot$  continuously until the desired setpoint is indicated.

**Example:** Pump set to minimum curve.

Figure 17 shows that the bottom light field is flashing, indicating minimum curve.

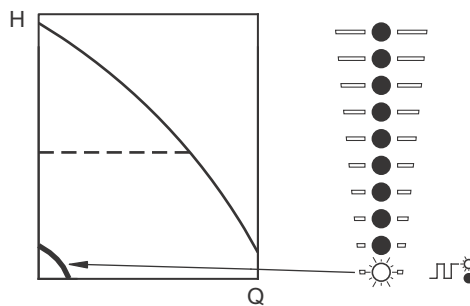





TM05 4897 2812



Fig. 17 Minimum curve duty

### 11.1.2 Start or stop the system

Start each pump by pressing  or by continuously pressing  until the desired setpoint is indicated.

Stop the system by pressing  on each pump. When the pump is stopped, the "Stop" text next to the button will illuminate. Each pump can also be stopped by continuously pressing  until none of the light fields are on.





If a pump has been stopped by pressing , it can only be given free to operation by pressing  again.

If a pump has been stopped by pressing , it can only be restarted by pressing .

The pump can also be stopped with Grundfos GO Remote or via a digital input set to "External stop". See section 16. [Priority of settings](#).

### 11.1.3 Resetting of fault indications

A fault indication can be reset in one of the following ways:

- Via the digital input if it has been set to "Alarm resetting".
- Briefly press  or  on one of the pumps. This will not change the setpoint.  
A fault indication cannot be reset by pressing  or  if the buttons have been locked.
- Switch off the power supply until the indicator lights are off.
- Switch the external start/stop input off and then on again.
- With Grundfos GO Remote.

## 12. Grundfos GO Remote

The system is designed for wireless radio or infrared communication with Grundfos GO Remote.

Grundfos GO Remote enables setting of functions and gives access to status overviews, technical product information and actual operating parameters.

Grundfos GO Remote offers three different mobile interfaces (MI). See fig. 18.

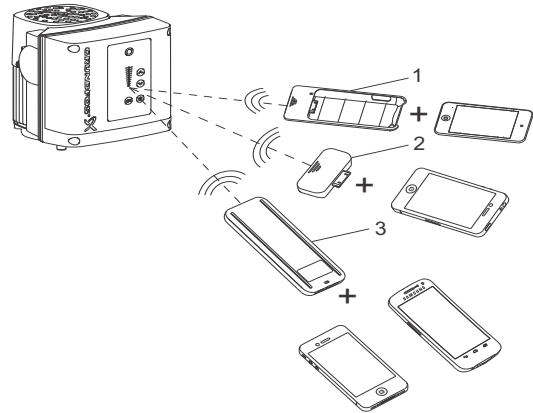

T.M05 5383 4312

**Fig. 18** Grundfos GO Remote communicating with the pump via radio or infrared light

Pos.	Description
1	Grundfos MI 201: Consists of an Apple iPod Touch 4G and a Grundfos cover.
2	Grundfos MI 202: Add-on module which can be used in conjunction with an Apple iPhone or iPod with 30-pin connector and iOS 5.0 or later, e.g. fourth generation iPhone or iPod.  Grundfos MI 204: Add-on module which can be used in conjunction with an Apple iPhone or iPod with Lightning connector, e.g. fifth generation iPhone or iPod. (The MI 204 is also available together with an Apple iPod touch and a cover.)
3	Grundfos MI 301: Separate module enabling radio or infrared communication. The module can be used in conjunction with an Android or iOS-based Smartphone with Bluetooth connection.



### 12.1 Communication

When Grundfos GO Remote communicates with the pump, the indicator light in the middle of Grundfos Eye will flash green. See section 17. [Grundfos Eye](#).

Communication must be established using one of these communication types:

- radio communication
- infrared communication.

#### 12.1.1 Radio communication

Radio communication can take place at distances up to 30 metres. Enable communication by pressing  or  on the pump control panel.

#### 12.1.2 Infrared communication

When communicating via infrared light, point Grundfos GO Remote at the pump control panel.

## 12.2 Menu overview for Grundfos GO Remote

### 12.2.1 Main menus

	Menu or function available for system	Menu or function available for pump
<b>Dashboard</b>	•	•
<b>Status</b>	•	•
<b>Settings</b>	•	•
Setpoint	•	
Operating mode	•	
Control mode	•	
Pipe filling function	•	
Buttons on product		•
LiqTec		•
Stop function	•	
Controller	•	
Operating range		•
Ramps	•	
Pump number		•
Radio communication		•
Analog input 1		•
Analog input 2		•
Digital input 1		•
Digital input 2		•
Signal relay 1		•
Signal relay 2		•
Limit 1 exceeded		•
Limit 2 exceeded		•
Standstill heating		•
Motor bearing monitoring		•
Service		•
Date and time		•
Store settings		•
Recall settings		•
Undo		•
Pump name		•
Unit configuration		•
<b>Alarms and warnings</b>		•
<b>Assist</b>		•
<b>Product information</b>		•

## 13. Multi-master function

### 13.1 Systems with one outlet-pressure sensor

To enable the system to deliver a constant pressure, an outlet-pressure sensor must be connected to and configured on at least one of the pumps. The pump with this sensor will function as master pump and control the system.

If the master pump is switched off or stopped due to an alarm, the other pumps in the system will stop.

If it is not possible to remove the cause of the alarm on the master pump, another pump can function as master pump. Connect the outlet-pressure sensor to one of the other pumps and configure it with Grundfos GO Remote. The system can now be restarted.

### 13.2 Systems with two or more outlet-pressure sensors

If two or more pumps in the system are configured with an outlet-pressure sensor, they can all function as master pumps. As standard, the pump with the lowest number will be the master pump. From factory, the master pump is marked with number 1.

If master pump 1 is switched off or stopped due to an alarm, one of the other master pumps will automatically take over the control of the system.

## 14. Protective functions

It is important that any protective function, for example dry-running protection or external start/stop that is detected via a digital input, is connected to and configured on all the pumps with an outlet-pressure sensor.

If an additional sensor is used, for example for the limit-exceeded function or setpoint influence, this sensor must also be connected to all pumps with an outlet-pressure sensor. Alternatively, an additional sensor per pump with an outlet-pressure sensor can be installed.

### 14.1 Dry-running protection



Hydro Multi-E must be protected against dry running.

Types of dry-running protection:

- a pressure switch which is factory-fitted to the inlet manifold. See section [14.1.1 Pressure switch](#).
- a level switch fitted in a water tank. See section [14.1.2 Level switch](#).

#### 14.1.1 Pressure switch

As standard, Hydro Multi-E is fitted with an adjustable pressure switch as dry-running protection. The pressure switch is fitted to the inlet manifold.

If the inlet pressure is below the lower switching point, the system cannot start.



If the pressure switch has stopped the system during operation due to the inlet pressure being too low, the inlet pressure must increase to a pressure that is higher than the setting of the upper switching point before the system can restart.

If necessary, adjust the lower switching point by turning screw A and adjust the upper switching point to a value higher than the lower switching point by turning screw B. See fig. 19.



Do not set the lower switching point to a value below the minimum inlet pressure. See section [7.6 Minimum inlet pressure](#).

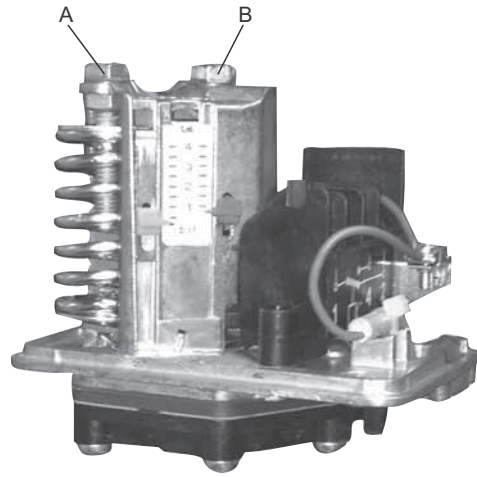

Fig. 19 Adjustment of switching points

Pos.	Description
A	Low pressure SP
B	High pressure SP

TM05 8436 2313

**14.1.2 Level switch**

The system can be optionally fitted with a level switch, either from factory or after delivery. The level switch can for instance monitor the water level in a tank connected to the inlet manifold and be connected to one of the digital inputs. See section *Advanced functional module (FM 300)*.

Furthermore, the digital input must be configured with a Grundfos GO Remote to detect dry running.

The system must be restarted manually if it has been stopped due to dry running.

**Advanced functional module (FM 300)**

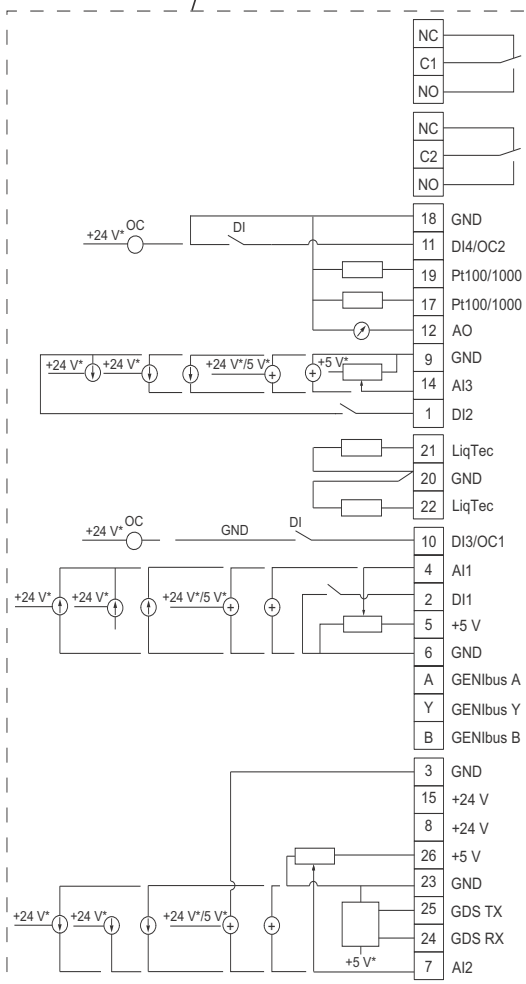
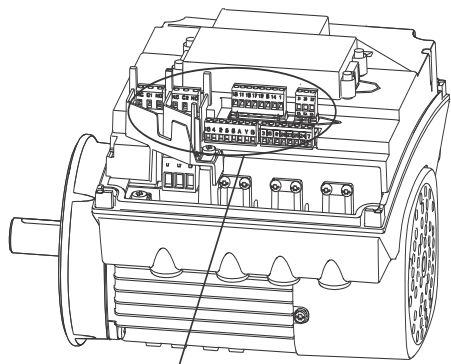

TM05 3509 3512

\* If an external supply source is used, there must be a connection to GND.

Terminal	Type	Function
NC	Normally closed contact	Signal relay 1 (LIVE or SELV)
C1	Common	
NO	Normally open contact	
NC	Normally closed contact	Signal relay 2 (SELV only)
C2	Common	
NO	Normally open contact	
18	GND	Ground
11	DI4/OC2	Digital input/output, configurable. Open collector: Maximum 24 V resistive or inductive.
19	Pt100/1000	Pt100/1000 sensor input 2
17	Pt100/1000	Pt100/1000 sensor input 1
12	AO	Analog output: 0-20 mA / 4-20 mA 0-10 V
9	GND	Ground
14	AI3	Analog input: 0-20 mA / 4-20 mA 0-10 V
1	DI2	Digital input, configurable
21	LiqTec	LiqTec sensor input 1 (white conductor)
20	GND	Ground (brown and black conductors)
22	LiqTec	LiqTec sensor input 2 (blue conductor)
10	DI3/OC1	Digital input/output, configurable. Open collector: Maximum 24 V resistive or inductive.
4	AI1	Analog input: 0-20 mA / 4-20 mA 0.5 - 3.5 V / 0-5 V / 0-10 V
2	DI1	Digital input, configurable
5	+5 V	Supply to potentiometer and sensor
6	GND	Ground
A	GENIbus, A	GENIbus, A (+)
Y	GENIbus, Y	GENIbus, GND
B	GENIbus, B	GENIbus, B (-)
3	GND	Ground
15	+24 V	Supply
8	+24 V	Supply
26	+5 V	Supply to potentiometer and sensor
23	GND	Ground
25	GDS TX	Grundfos Digital Sensor output
24	GDS RX	Grundfos Digital Sensor input
7	AI2	Analog input: 0-20 mA / 4-20 mA 0.5 - 3.5 V / 0-5 V / 0-10 V

## 15. Bus signal

Bus communication is enabled via an RS-485 input.

The communication is carried out according to the Grundfos GENIbus protocol and enables connection to a building management system or another external control system.

Via a bus signal, it is possible to remote-set motor operating parameters, such as setpoint and operating mode. At the same time, the motor can, via the bus, provide status information about important parameters, such as actual value of control parameter, input power and fault indications.

Contact Grundfos for further information.



If a bus signal is used, the number of settings available via Grundfos GO Remote will be reduced.

## 16. Priority of settings

The system can always be set to operate at maximum speed or to stop with Grundfos GO Remote.

If two or more functions are enabled at the same time, the system will operate according to the function with the highest priority.

**Example:** If, via the digital input, the system has been set to maximum speed, the pump control panel or Grundfos GO Remote can only set the system to "Manual" or "Stop".

The priority of the settings appears from the table below:

Priority	Start/stop button	Control panel on pump or Grundfos GO Remote	Digital input	Bus communication
1	Stop			
2		Stop*		
3		Manual		
4		Max. speed*		
5			Stop	
6				Stop
7				Max. speed
8				Min. speed
9				Start
10			Max. speed	
11		Min. speed		
12			Min. speed	
13			Start	
14		Start		

\* If the bus communication is interrupted, the system will resume its previous operating mode, for example "Stop", selected on the control panel of the pump running as master or with Grundfos GO Remote.



## 17. Grundfos Eye

The operating condition of Hydro Multi-E is indicated by Grundfos Eye on the pump control panels. See fig. 20, pos. A.

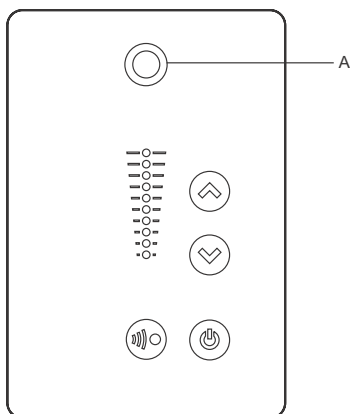

TM05 5993 4312

Fig. 20 Grundfos Eye





























































Grundfos Eye	Indication	Description
	No lights are on.	Power off. The motor is not running.
	The two opposite green indicator lights are rotating in the direction of rotation of the motor when seen from the non-drive end.	The power is on. The motor is running.
	The two opposite green indicator lights are permanently on.	The power is on. The motor is not running.
	One yellow indicator light is rotating in the direction of rotation of the motor when seen from the non-drive end.	Warning. The motor is running.
	One yellow indicator light is permanently on.	Warning. The motor has stopped.
	Two opposite red indicator lights are flashing simultaneously.	Alarm. The motor has stopped.
	The green indicator light in the middle flashes quickly four times.	Remote control with Grundfos GO Remote via radio. The motor is trying to communicate with Grundfos GO Remote. The motor is highlighted in the Grundfos GO Remote display to inform the user of the location of the motor.
	The green indicator light in the middle flashes continuously.	When you have selected the motor in the Grundfos GO Remote menu, the green indicator light in the middle flashes continuously. Press  on the pump control panel to allow remote control and data exchange via Grundfos GO Remote.
	The green indicator light in the middle is permanently on.	Remote control with Grundfos GO Remote via radio. The motor is communicating with Grundfos GO Remote via radio connection.
	The green indicator light in the middle flashes quickly while Grundfos GO Remote is exchanging data with the motor. It takes a few seconds.	Remote control with Grundfos GO Remote via infrared light. The motor is receiving data from Grundfos GO Remote via infrared communication.

## 18. Signal relays

The motor has two outputs for potential-free signals via two internal relays.

The signal outputs can be set to "Operation", "Running", "Ready", "Alarm" and "Warning".

The functions of the two signal relays appear from the table below:

Description	Grundfos Eye	Contact position for signal relays when activated					Operating mode
		Operation	Running	Ready	Alarm	Warning	
Power off.	 Off						-
Pump running in "Normal" mode.	 Green, rotating						Normal, Min. or Max.
Pump running in "Manual" mode.	 Green, rotating						Manual
Pump in operating mode "Stop".	 Green, steady						Stop
Warning, but the pump is running.	 Yellow, rotating						Normal, Min. or Max.
Warning, but the pump is running in "Manual" mode.	 Yellow, rotating						Manual
Warning, but the pump was stopped via "Stop" command.	 Yellow, steady						Stop
Alarm, but the pump is running.	 Red, rotating						Normal, Min. or Max.
Alarm, but the pump is running in "Manual" mode.	 Red, rotating						Manual
Pump stopped due to an alarm.	 Red, flashing						Stop

## 19. Digital input

Hydro Multi-E has a digital input for external faults. The input has been factory-set to external fault and will be active in closed condition.

**Functional diagram: input for digital function**

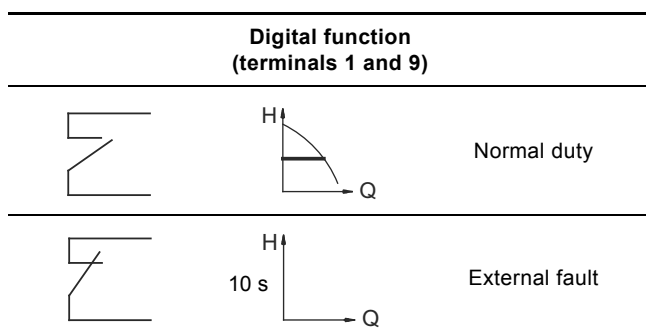

If the digital input is active for more than 10 seconds (s), Hydro Multi-E will stop because of an external fault.

The digital input is used for the dry-running protection.

## 20. Data communication

It is possible to connect the system to an external network. The connection can be made via a GENIbus-based network or a network based on another fieldbus protocol.

The system can communicate via CIM modules. This enables the system to communicate with different types of network solutions. A CIM module is an add-on communication interface module. The CIM module enables data transmission between the pump and an external system, for example a BMS or SCADA system.

For further information on CIM modules, see [www.grundfos.com](http://www.grundfos.com) (Grundfos Product Center) or contact Grundfos.

## 21. Insulation resistance



Do not measure the insulation resistance of motor windings or an installation incorporating motors with integrated frequency converters using high-voltage megging equipment, as this may damage the built-in electronics.

## 22. Maintenance

### DANGER

#### Electric shock



Death or serious personal injury  
- Switch off the power supply and wait at least five minutes before you start any work on the product. Make sure that the power supply cannot be accidentally switched on.

### 22.1 Pumps

Pump bearings and shaft seals are maintenance-free.

If CRE or CRIE pumps are to be drained for a long period of inactivity, remove one of the coupling guards to inject a few drops of silicone oil on the shaft between the pump head and the coupling. This will prevent the shaft seal faces from sticking.

### 22.2 Motors

Keep motor cooling fins and fan blades clean to ensure sufficient cooling of the motor and electronics.

### 22.3 Breaker cabinet

The breaker cabinet is maintenance-free. Keep it clean and dry.

## 23. Shutdown

Shut down the system with the main switch in the breaker cabinet.

### DANGER

#### Electric shock



Death or serious personal injury  
- Do not touch the conductors in front of the main switch as they are still energised.

To shut down a pump, switch off the circuit breaker of the pump.

### 23.1 Frost protection

If pumps are not used during periods of frost, they must be drained to avoid damage.

Drain the pump by loosening the vent screw in the pump head and removing the drain plug from the base.

Do not tighten the vent screw or refit the drain plug until the system is to be used again.

### 23.2 Service kits

See Grundfos Product Center for service manuals.

## 24. Fault finding

### DANGER

#### Electric shock



Death or serious personal injury

- Switch off the power supply and wait at least five minutes before you start any work on the product. Make sure that the power supply cannot be accidentally switched on.

Fault	Cause	Remedy
1. Hydro Multi-E does not run when started.	a) The actual pressure is higher than or equal to the setpoint set.	Wait until the pressure has dropped, or lower the pressure on the outlet side of Hydro Multi-E, and check that the booster system starts.
	b) The power supply is disconnected.	Connect the power supply.
	c) The circuit breakers have cut out.	Correct the fault and cut in the-circuit breakers.
	d) The internal motor protection is activated.	Contact Grundfos.
	e) The circuit breaker is defective.	Replace the circuit breaker.
	f) The motor is defective.	Repair or replace the motor.
	g) Outlet-pressure sensor fault. <ul style="list-style-type: none"> <li>- The outlet-pressure sensor is defective.</li> <li>- The cable is broken or short-circuited.</li> </ul>	<ul style="list-style-type: none"> <li>Replace the outlet-pressure sensor.</li> <li>Repair or replace the cable.</li> </ul>
2. Hydro Multi-E starts, but stops immediately afterwards. The operating pressure is not reached.	a) Dry running or no inlet pressure.	Check the supply of water to Hydro Multi-E. When the inlet pressure has been reestablished, the pumps will restart after 15 seconds.
3. Hydro Multi-E is stopped and cannot restart.	a) Outlet-pressure sensor fault. <ul style="list-style-type: none"> <li>- The outlet-pressure sensor is defective.</li> <li>- The cable is broken or short-circuited.</li> </ul>	<ul style="list-style-type: none"> <li>Replace the outlet-pressure sensor. Outlet-pressure sensors with 0-20 mA or 4-20 mA output signals are monitored by Hydro Multi-E.</li> <li>Repair or replace the cable.</li> </ul>
	b) Terminal box unit fault. <ul style="list-style-type: none"> <li>- The power supply is disconnected on pump 1.</li> <li>- The terminal box is defective.</li> </ul>	<ul style="list-style-type: none"> <li>Connect the power supply.</li> <li>Replace the terminal box of pump 1. Contact Grundfos.</li> </ul>
	4. Unstable water delivery from Hydro Multi-E (applies only to very low consumption).	<ul style="list-style-type: none"> <li>a) The inlet pressure is too low.</li> <li>b) The inlet pipe or pumps are partly blocked by impurities.</li> <li>c) The pumps suck air.</li> <li>d) The outlet-pressure sensor is defective.</li> </ul>
5. Pumps are running, but deliver no water.	a) The inlet pipe or pumps are blocked by impurities.	Clean the inlet pipe or pumps.
	b) The non-return valve is blocked in the closed position.	Clean the non-return valve. The non-return valve must move freely.
	c) The inlet pipe is leaky.	Check the inlet pipe for leakages.
	d) Air in inlet pipe or pumps.	Vent the pumps. Check the inlet pipe for leakages.
6. Hydro Multi-E is unable to reach the setpoint.	a) The cable is broken or short-circuited (GENbus communication between pump 1 and pump 2/3).	Repair or replace the cable.
	b) Pump 2 or 3 is out of operation.	Connect the power supply to the pump and check the pump condition.
7. Leakage from a shaft seal.	a) The shaft seal is defective.	Replace the shaft seal.
	b) CRE and CRIE pumps: The height adjustment of the pump shaft is inaccurate.	Readjust the shaft height.
8. Noise.	a) The pumps are cavitating.	Clean the inlet pipe or pumps and possibly the inlet strainer.
	b) CRE and CRIE pumps: The pumps do not rotate freely (frictional resistance) due to inaccurate height adjustment of the pump shaft.	Readjust the shaft height. See the CR, CRI, CRN installation and operating instructions supplied with Hydro Multi-E.
9. Very frequent starts and stops.	a) Wrong diaphragm tank precharge pressure.	Check the precharge pressure.
	b) The difference between start and stop pressures is too small. <b>Note:</b> This situation will only arise if emergency operation is installed.	Increase the differential pressure setting on each pressure switch.

## 25. Technical data, Hydro Multi-E with single-phase pumps

### 25.1 Supply voltage

3 x 380-415 V - 10 %/+ 10 %, 50/60 Hz, N, PE.

Check that the supply voltage and frequency correspond to the values stated on the nameplate.

#### Recommended fuse size

Motor size [kW]	Min. [A]	Max. [A]
0.37 - 0.75	6	10
1.1 - 1.5	10	16

Standard as well as quick-blow or slow-blow fuses may be used.

### 25.2 Leakage current

Motor size [kW]	Number of pumps in booster system	Leakage current [mA]
0.37 - 1.5	2	Less than 7
	3	Less than 10.5
	4	Less than 14

The leakage currents are measured in accordance with EN 61800-5-1:2007.

## 26. Technical data, Hydro Multi-E with three-phase pumps

### 26.1 Supply voltage

3 x 380-480 V - 10 %/+ 10 %, 50/60 Hz, PE.

Check that the supply voltage and frequency correspond to the values stated on the nameplate.

#### Recommended fuse size

Motor size [kW]	Min. [A]	Max. [A]
0.37 - 1.1	6	6
1.5	6	10
2.2	6	16
3	10	16
4	13	16
5.5	16	32
7.5	20	32
11	32	32

Standard as well as quick-blow or slow-blow fuses may be used.

### 26.2 Leakage current

Motor size [kW]	Number of pumps in booster system	Leakage current [mA]
0.3 - 11 (supply voltage less than 400 V)	2	Less than 7
	3	Less than 10.5
	4	Less than 14
0.37 - 11 (supply voltage greater than 400 V)	2	Less than 10
	3	Less than 15
	4	Less than 20

The leakage currents are measured in accordance with EN 61800-5-1:2007.

## 27. Inputs and outputs

### Ground reference (GND)

All voltages refer to GND.

All currents return to GND.

### Absolute maximum voltage and current limits

Exceeding the following electrical limits may result in severely reduced operating reliability and motor life:

Relay 1:

Maximum contact load: 250 VAC, 2 A or 30 VDC, 2 A.

Relay 2:

Maximum contact load: 30 VDC, 2 A.

GENI terminals: -5.5 to 9.0 VDC or less than 25 mADC.

Other input/output terminals: -0.5 to 26 VDC or less than 15 mADC.

### Digital inputs (DI)

Internal pull-up current greater than 10 mA at Vi equal to 0 VDC.

Internal pull-up to 5 VDC (currentless for Vi greater than 5 VDC).

Certain low logic level: Vi less than 1.5 VDC.

Certain high logic level: Vi greater than 3.0 VDC.

Hysteresis: No.

Screened cable: 0.5 - 1.5 mm<sup>2</sup> / 28-16 AWG.

Maximum cable length: 500 m.

### Open-collector digital outputs (OC)

Current sinking capability: 75 mADC, no current sourcing.

Load types: Resistive and/or inductive.

Low-state output voltage at 75 mADC: Max. 1.2 VDC.

Low-state output voltage at 10 mADC: Max. 0.6 VDC.

Overcurrent protection: Yes.

Screened cable: 0.5 - 1.5 mm<sup>2</sup> / 28-16 AWG.

Maximum cable length: 500 m.

### Analog inputs (AI)

Voltage signal ranges:

- 0.5 - 3.5 VDC, AL AU.
- 0-5 VDC, AU.
- 0-10 VDC, AU.

Voltage signal: Ri is greater than 100 kΩ at +25 °C.

Leak currents may occur at high operating temperatures. Keep the source impedance low.

Current signal ranges:

- 0-20 mADC, AU.
- 4-20 mADC, AL AU.

Current signal: Ri is equal to 292 Ω.

Current overload protection: Yes. Change to voltage signal.

Measurement tolerance: - 0/+ 3 % of full scale (max.-point coverage).

Screened cable: 0.5 - 1.5 mm<sup>2</sup> / 28-16 AWG.

Maximum cable length: 500 m (exclusive of potentiometer).

Potentiometer connected to +5 V, GND, any AI:

Use maximum 10 kΩ.

Maximum cable length: 100 m.

**Analog output (AO)**

Current sourcing capability only.

Voltage signal:

- Range: 0-10 VDC.
- Minimum load between AO and GND: 1 k $\Omega$ .
- Short-circuit protection: Yes.

Current signal:

- Ranges: 0-20 and 4-20 mA DC.
- Maximum load between AO and GND: 500  $\Omega$ .
- Open-circuit protection: Yes.

Tolerance: - 0/+ 4 % of full scale (max-point coverage).

Screened cable: 0.5 - 1.5 mm<sup>2</sup> / 28-16 AWG.

Maximum cable length: 500 m.

**Pt100/1000 inputs (PT)**

Temperature range:

- Minimum -30 °C (88/882  $\Omega$ ).
- Maximum +180 °C (168/1685  $\Omega$ ).

Measurement tolerance:  $\pm$  1.5 °C.

Measurement resolution: Less than 0.3 °C.

Automatic range detection (Pt100 or Pt1000): Yes.

Sensor fault alarm: Yes.

Screened cable: 0.5 - 1.5 mm<sup>2</sup> / 28-16 AWG.

Use Pt100 for short wires.

Use Pt1000 for long wires.

**LiqTec sensor inputs**

Use Grundfos LiqTec sensor only.

Screened cable: 0.5 - 1.5 mm<sup>2</sup> / 28-16 AWG.

**Grundfos Digital Sensor input and output (GDS)**

Use Grundfos Digital Sensor only.

**Power supplies (+5 V, +24 V)****+5 V:**

- Output voltage: 5 VDC - 5 %/+ 5 %.
- Maximum current: 50 mA DC (sourcing only).
- Overload protection: Yes.

**+24 V:**

- Output voltage: 24 VDC - 5 %/+ 5 %.
- Maximum current: 60 mA DC (sourcing only).
- Overload protection: Yes.

**Digital outputs (relays)**

Potential-free changeover contacts.

Minimum contact load when in use: 5 VDC, 10 mA.

Screened cable: 0.5 - 2.5 mm<sup>2</sup> / 28-12 AWG.

Maximum cable length: 500 m.

**Bus input**

Grundfos GENiBus protocol, RS-485.

Screened 3-core cable: 0.5 - 1.5 mm<sup>2</sup> / 28-16 AWG.

Maximum cable length: 500 m.

**28. Other technical data****EMC (electromagnetic compatibility)**

According to EN 61000-6-2:2005 and 61000-6-3:2007.

Residential areas, unlimited distribution, corresponding to CISPR 11, class B, group 1.

Industrial areas, unlimited distribution, corresponding to CISPR 11, class A, group 1.

Contact Grundfos for further information.

**Enclosure class**

Standard: IP55 (IEC 34-5).

**Insulation class**

F (IEC 85).

**Ambient temperature**

- During operation: 0 to +40 °C.
- During storage or transport: -40 to +60 °C.

**29. Sound pressure level****29.1 Hydro Multi-E with single-phase pumps**

Motor size [kW]	Number of pumps in booster system		Sound pressure level [dB(A)]
	2	3	
0.37 - 1.1	•		60
		•	63
1.5	•		67
		•	69

**29.2 Hydro Multi-E with three-phase pumps**

Motor size [kW]	Number of pumps in booster system		Sound pressure level [dB(A)]
	2	3	
1.5	•		67
		•	69
2.2	•		67
		•	69
3.0	•		71
		•	73
4.0	•		71
		•	73
5.5	•		71
		•	73
7.5	•		77
		•	79
11	•		77
		•	79

**30. Disposal**

This product or parts of it must be disposed of in an environmentally sound way:

1. Use the public or private waste collection service.
2. If this is not possible, contact the nearest Grundfos company or service workshop.

Subject to alterations.

NPSH

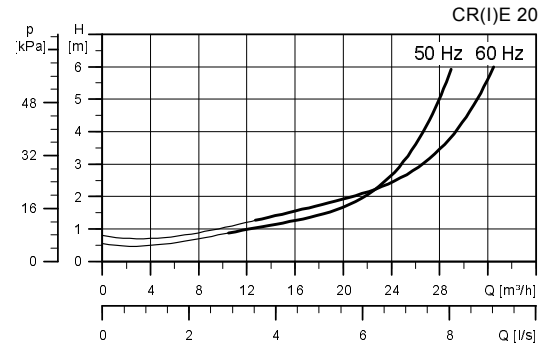
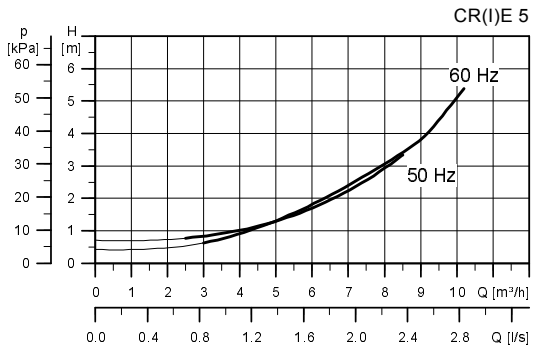
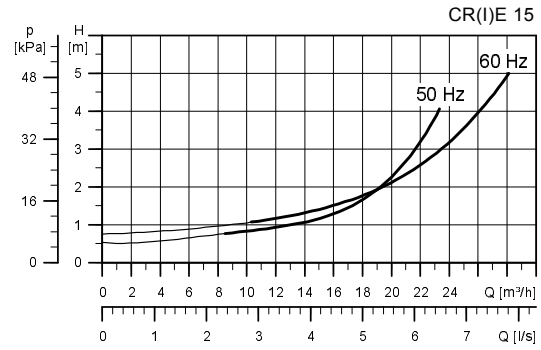
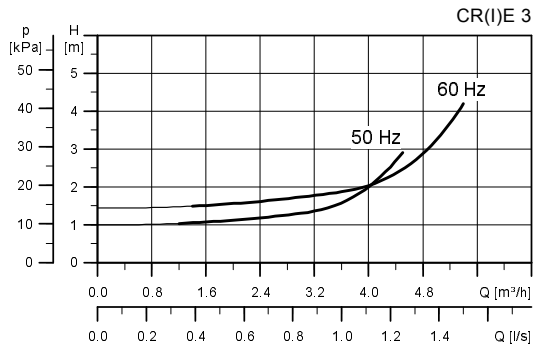
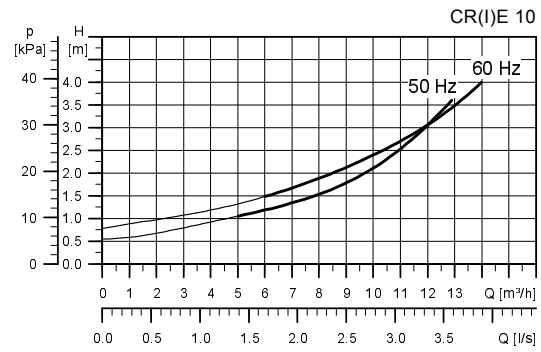
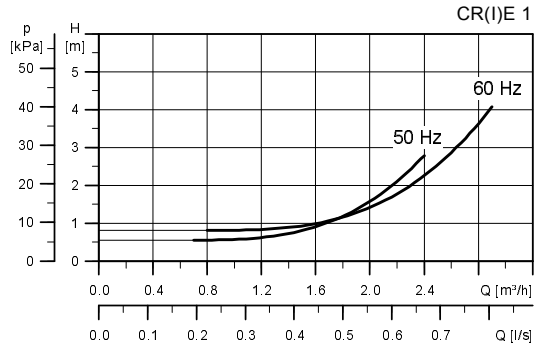

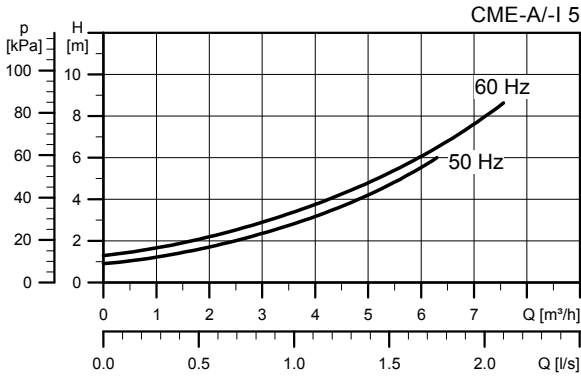

TM05 2004 4211

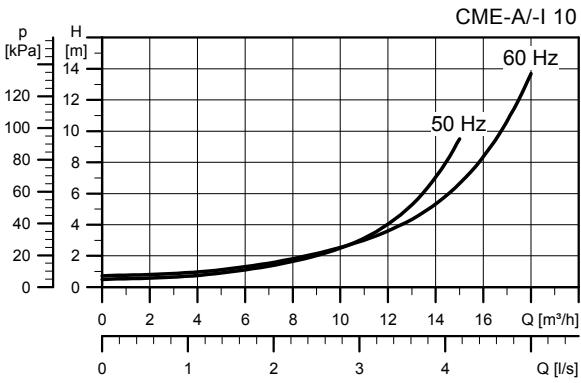

TM05 2005 4211

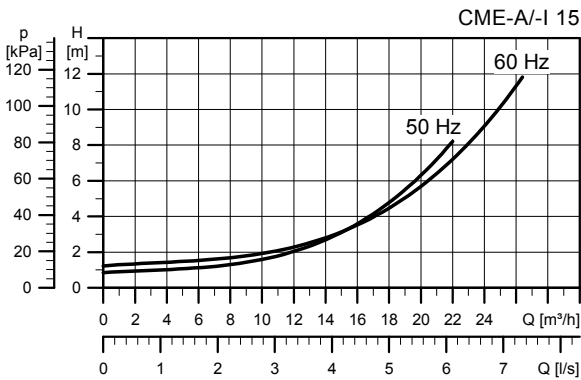

TM05 2006 4211

Vapour pressure

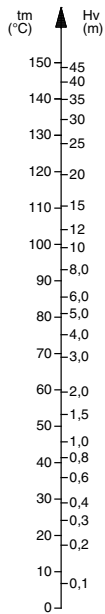

TM00 3037 3493



## Declaration of conformity

**GB: EC declaration of conformity**

We, Grundfos, declare under our sole responsibility that the products Hydro Multi-E, to which this declaration relates, are in conformity with these Council directives on the approximation of the laws of the EC member states:

**DK: EU-overensstemmelseserklæring**

Vi, Grundfos, erklærer under ansvar at produkterne Hydro Multi-E som denne erklæring omhandler, er i overensstemmelse med disse af Rådets direktiver om indbyrdes tilnærmelse til EU-medlemsstaternes lovgivning:

**EE: EL vastavusdeklaratsioon**

Meie, Grundfos, deklareerime enda ainuvastutusel, et toode Hydro Multi-E, mille kohta käesolev juhend käib, on vastavuses EÜ Nõukogu direktiividega EMÜ liikmesriikide seaduste ühitamise kohta, mis käsitlevad:

**ES: Declaración CE de conformidad**

Nosotros, Grundfos, declaramos bajo nuestra entera responsabilidad que los productos Hydro Multi-E, a los cuales se refiere esta declaración, están conformes con las Directivas del Consejo en la aproximación de las leyes de los Estados Miembros del EM:

**HR: EZ izjava o usklađenosti**

Mi, Grundfos, izjavljujemo pod vlastitom odgovornošću da je proizvod Hydro Multi-E, uz kuru attiecas šis paziņojums, atbilst šādām Padomes Vijeća o usklađivanju zakona država članica EU:

**LV: EK atbilstības deklarācija**

Sabiedrība GRUNDFOS ar pilnu atbildību dara zināmu, ka produkts Hydro Multi-E, uz kuru attiecas šis paziņojums, atbilst šādām Padomes direktīvām par tuvināšanas EK dalībvalstu likumdošanas normām:

**HU: EK megfélelőselégi nyilatkozat**

Mi, a Grundfos, egyedüli felelősséggel kijelentjük, hogy a Hydro Multi-E termékek, amelyekre jelen nyilatkozat vonatkozik, megfelelnek az Európai Unió tagállamainak jogi irányelveit összefoglaló tanács alábbi előírásainak:

**PL: Deklaracja zgodności WE**

My, Grundfos, oświadczamy z pełną odpowiedzialnością, że nasze wyroby Hydro Multi-E, których deklaracja niniejsza dotyczy, są zgodne z następującymi wytycznymi Rady d/s ujednolicenia przepisów prawnych krajów członkowskich WE:

**RU: Декларация о соответствии ЕС**

Мы, компания Grundfos, со всей ответственностью заявляем, что изделия Hydro Multi-E, к которым относится настоящая декларация, соответствуют следующим Директивам Совета Евросоюза об унификации законодательных предписаний стран-членов ЕС:

**SI: ES izjava o skladnosti**

V Grundfosu s polno odgovornostjo izjavljamo, da so naši izdelki Hydro Multi-E, na katere se ta izjava nanaša, v skladu z naslednjimi direktivami Sveta o približevanju zakonodaje za izenačevanje pravnih predpisov držav članic ES:

**SE: EG-försäkran om överensstämmelse**

Vi, Grundfos, försäkrar under ansvar att produkterna Hydro Multi-E, som omfattas av denna försäkran, är i överensstämmelse med rådets direktiv om inbördes närmande till EU-medlemsstaternas lagstiftning, avseende:

**CZ: ES prohlášení o shodě**

My firma Grundfos prohlašujeme na svou plnou odpovědnost, že výrobky Hydro Multi-E na něž se toto prohlášení vztahuje, jsou v souladu s ustanoveními směrnice Rady pro sblížení právních předpisů členských států Evropského společenství v oblastech:

**DE: EG-Konformitätserklärung**

Wir, Grundfos, erklären in alleiniger Verantwortung, dass die Produkte Hydro Multi-E, auf die sich diese Erklärung bezieht, mit den folgenden Richtlinien des Rates zur Angleichung der Rechtsvorschriften der EU-Mitgliedsstaaten übereinstimmen:

**GR: Δήλωση συμμόρφωσης EC**

Εμείς, η Grundfos, δηλώνουμε με αποκλειστικά δική μας ευθύνη ότι τα προϊόντα Hydro Multi-E στα οποία αναφέρεται η παρούσα δήλωση, συμμορφώνονται με τις εξής Οδηγίες του Συμβουλίου περί προσέγγισης των νομοθεσιών των κρατών μελών της ΕΕ:

**FR: Déclaration de conformité CE**

Nous, Grundfos, déclarons sous notre seule responsabilité, que les produits Hydro Multi-E, auxquels se réfère cette déclaration, sont conformes aux Directives du Conseil concernant le rapprochement des législations des Etats membres CE relatives aux normes énoncées ci-dessous :

**IT: Dichiarazione di conformità CE**

Grundfos dichiara sotto la sua esclusiva responsabilità che i prodotti Hydro Multi-E, ai quali si riferisce questa dichiarazione, sono conformi alle seguenti direttive del Consiglio riguardanti il riavvicinamento delle legislazioni degli Stati membri CE:

**LT: EB atitikties deklaracija**

Mes, Grundfos, su visa atsakomybe pareiškiame, kad gaminys Hydro Multi-E, kuriam skirta ši deklaracija, atitinka šias Tarybos Direktyvas dėl Europos Ekonominės Bendrijos šalių narių įstatymų suderinimo:

**NL: EC overeenkomstigheidsverklaring**

Wij, Grundfos, verklaren geheel onder eigen verantwoordelijkheid dat de producten Hydro Multi-E waarop deze verklaring betrekking heeft, in overeenstemming zijn met de Richtlijnen van de Raad in zake de onderlinge aanpassing van de wetgeving van de EG Lidstaten betreffende:

**PT: Declaração de conformidade CE**

A Grundfos declara sob sua única responsabilidade que os produtos Hydro Multi-E, aos quais diz respeito esta declaração, estão em conformidade com as seguintes Directivas do Conselho sobre a aproximação das legislações dos Estados Membros da CE:

**RO: Declarație de conformitate CE**

Noi, Grundfos, declarăm pe propria răspundere că produsele Hydro Multi-E, la care se referă această declarație, sunt în conformitate cu aceste Directive de Consiliu asupra armonizării legilor Statelor Membre CE:

**FI: EY-vaatimusten mukaisuusvakuutus**

Me, Grundfos, vakuutamme omalla vastuullamme, että tuotteet Hydro Multi-E, joita tämä vakuutus koskee, ovat EY:n jäsenvaltioiden lainsäädännön yhdenmukaistamiseen tähtäävien Euroopan neuvoston direktiivien vaatimusten mukaisia seuraavasti:

**TR: EC uygunluk bildiřesi**

Grundfos olarak bu beyannameye konu olan Hydro Multi-E ürünlerinin, AB Üyesi Ülkelerin kanunlarını birbirine yaklařtırma üzerine Konsey Direktifleriyle uyumlu olduđunun yalnızca bizim sorumluluđumuz altında olduđunu beyan ederiz:

- 
- Machinery Directive (2006/42/EC).  
Standards used:  
EN 809:1998 and A1:2009.
  - Radio Equipment Directive (2014/53/EU)  
Standards used:  
EN 61800-5-1:2007, EN 61800-3:2004+A1:2012, EN 62479:2010,  
EN 301 489-1 V2.2.0, EN 301 489-17 V2.2.1, EN 300 328 V1.9.1,  
EN 301 511 V12.1.10, EN 301 489-1 V2.2.0, EN 301 489-7 V1.3.
  - ErP Directive (2009/125/EC)  
Motors:  
Commission Regulation (EC) No 640/2009  
Standards used:  
EN 60034-2-1:2007  
Water pumps:  
Commission Regulation No 547/2012.  
Applies only to water pumps marked with the minimum efficiency  
index MEI. See pump nameplate.

This EC declaration of conformity is only valid when published as part of the Grundfos installation and operating instructions (publication number 98491894 0517).

Bjerringbro, 7th April 2017



Svend Aage Kaae  
Technical Director  
Grundfos Holding A/S  
Poul Due Jensens Vej 7  
8850 Bjerringbro, Denmark

Person authorised to compile technical file and  
empowered to sign the EC declaration of conformity.

---

RUS

## Hydro Multi-E

### Руководство по эксплуатации

Руководство по эксплуатации на данное изделие является составным и включает в себя несколько частей:

Часть 1: настоящее «Руководство по эксплуатации».

Часть 2: электронная часть «Паспорт. Руководство по монтажу и эксплуатации» размещенная на сайте компании Грундфос. Перейдите по ссылке, указанной в конце документа.

Часть 3: информация о сроке изготовления, размещенная на фирменной табличке изделия.

#### Сведения о сертификации:

Насосы типа Hydro Multi-E сертифицированы на соответствие требованиям Технических регламентов Таможенного союза: ТР ТС 004/2011 «О безопасности низковольтного оборудования»; ТР ТС 010/2011 «О безопасности машин и оборудования»; ТР ТС 020/2011 «Электромагнитная совместимость технических средств».

KAZ

## Hydro Multi-E

### Пайдалану бойынша нұсқаулық

Атаулы өнімге арналған пайдалану бойынша нұсқаулық құрамалы болып келеді және келесі бөлімдерден тұрады:

1 бөлім: атаулы «Пайдалану бойынша нұсқаулық»

2 бөлім: Грундфос компаниясының сайтында орналасқан электронды бөлім «Төлқұжат, Құрастыру және пайдалану бойынша нұсқаулық». Құжат соңында көрсетілген сілтеме арқылы өтіңіз.

3 бөлім: өнімнің фирмалық тақташасында орналасқан шығарылған уақыты жөніндегі мәлімет

#### Сертификаттау туралы ақпарат:

Hydro Multi-E типті сорғылары «Төмен вольтты жабдықтардың қауіпсіздігі туралы» (ТР ТС 004/2011), «Машиналар және жабдықтар қауіпсіздігі туралы» (ТР ТС 010/2011) «Техникалық заттардың электрлі магниттік сәйкестілігі» (ТР ТС 020/2011) Кеден Одағының техникалық регламенттерінің талаптарына сәйкес сертификатталды.



KG

## Hydro Multi-E

### Пайдалануу боюнча колдонмо

Аталган жабдууну пайдалануу боюнча колдонмо курамдык жана өзүнө бир нече бөлүкчөнү камтыйт:

1-Бөлүк: «Пайдалануу боюнча колдонмо»

2-Бөлүк: «Паспорт. Пайдалануу жана монтаж боюнча колдонмо» электрондук бөлүгү Грундфос компаниянын сайтында жайгашкан. Документтин аягында көрсөтүлгөн шилтемеге кайрылыңыз.

3-Бөлүк: жабдуунун фирмалык тактасында жайгашкан даярдоо мөөнөтү тууралуу маалымат.

### Шайкештик жөнүндө декларация

Hydro Multi-E 2.2 түрүндөгү соргучтар Бажы Биримдиктин Техникалык регламенттин талаптарына ылайыктуу тастыкталган: TP ТБ 004/2011 «Төмөн вольттук жабдуунун коопсуздугу жөнүндө»; TP ТБ 010/2011 «Жабдуу жана машиналардын коопсуздугу жөнүндө»; TP ТБ 020/2011 «Техникалык каражаттардын электрмагниттик шайкештиги».

ARM

## Hydro Multi-E

Շահագործման ձեռնարկ

Տվյալ սարքավորման շահագործման ձեռնարկը բաղկացած է մի քանի մասերից.

Մաս 1. սույն «Շահագործման ձեռնարկ»:

Մաս 2. էլեկտրոնային մաս. այն է՝ «Անձնագիր: Մոնտաժման և

շահագործման ձեռնարկ» տեղադրված «Գրունդֆոս». Անցեք փաստաթղթի վերջում նշված հղումով.

Մաս 3. տեղեկություն արտադրման ամսաթվի վերաբերյալ՝ նշված սարքավորման պիտակի վրա:

Տեղեկություններ հավաստագրման մասին՝

Hydro Multi-E տիպի պոմպերը սերտիֆիկացված են համաձայն Մաքսային Միության տեխնիկական կանոնակարգի պահանջների՝ TP TC 004/2011 «Ցածրավոլտ սարքավորումների վերաբերյալ», TP TC 010/2011 «Մեքենաների և սարքավորումների անվտանգության վերաբերյալ» ; TP TC 020/2011

«Տեխնիկական միջոցների էլեկտրամագնիսական համատեղելիության վերաբերյալ»:



<http://net.grundfos.com/qr/i/98881635>

10000136811	0517
ECM: 1209618	

**Argentina**

Bombas GRUNDFOS de Argentina S.A.  
Ruta Panamericana km. 37.500 Centro  
Industrial Garin  
1619 Garin Pcia. de B.A.  
Phone: +54-3327 414 444  
Telefax: +54-3327 45 3190

**Australia**

GRUNDFOS Pumps Pty. Ltd.  
P.O. Box 2040  
Regency Park  
South Australia 5942  
Phone: +61-8-8461-4611  
Telefax: +61-8-8340 0155

**Austria**

GRUNDFOS Pumpen Vertrieb Ges.m.b.H.  
Grundfosstraße 2  
A-5082 Grödig/Salzburg  
Tel.: +43-6246-883-0  
Telefax: +43-6246-883-30

**Belgium**

N.V. GRUNDFOS Bellux S.A.  
Boomssesteenweg 81-83  
B-2630 Aartselaar  
Tél.: +32-3-870 7300  
Télécopie: +32-3-870 7301

**Belarus**

Представительство ГРУНДФОС в  
Минске  
220125, Минск  
ул. Шафарнянская, 11, оф. 56, БЦ  
«Порт»  
Тел.: +7 (375 17) 286 39 72/73  
Факс: +7 (375 17) 286 39 71  
E-mail: minsk@grundfos.com

**Bosnia and Herzegovina**

GRUNDFOS Sarajevo  
Zmaja od Bosne 7-7A,  
BH-71000 Sarajevo  
Phone: +387 33 592 480  
Telefax: +387 33 590 465  
www.ba.grundfos.com  
e-mail: grundfos@bih.net.ba

**Brazil**

BOMBAS GRUNDFOS DO BRASIL  
Av. Humberto de Alencar Castelo Branco,  
630  
CEP 09850 - 300  
São Bernardo do Campo - SP  
Phone: +55-11 4393 5533  
Telefax: +55-11 4343 5015

**Bulgaria**

Grundfos Bulgaria EOOD  
Slatina District  
Iztochna Tangenta street no. 100  
BG - 1592 Sofia  
Tel. +359 2 49 22 200  
Fax. +359 2 49 22 201  
email: bulgaria@grundfos.bg

**Canada**

GRUNDFOS Canada Inc.  
2941 Brighton Road  
Oakville, Ontario  
L6H 6C9  
Phone: +1-905 829 9533  
Telefax: +1-905 829 9512

**China**

GRUNDFOS Pumps (Shanghai) Co. Ltd.  
10F The Hub, No. 33 Suhong Road  
Minhang District  
Shanghai 201106  
PRC  
Phone: +86 21 612 252 22  
Telefax: +86 21 612 253 33

**COLOMBIA**

GRUNDFOS Colombia S.A.S.  
Km 1.5 vía Siberia-Cota Conj. Potrero  
Chico,  
Parque Empresarial Arcos de Cota Bod.  
1A.  
Cota, Cundinamarca  
Phone: +57(1)-2913444  
Telefax: +57(1)-8764586

**Croatia**

GRUNDFOS CROATIA d.o.o.  
Buzinski prilaz 38, Buzin  
HR-10010 Zagreb  
Phone: +385 1 6595 400  
Telefax: +385 1 6595 499  
www.hr.grundfos.com

**GRUNDFOS Sales Czechia and****Slovakia s.r.o.**

Čajkovského 21  
779 00 Olomouc  
Phone: +420-585-716 111

**Denmark**

GRUNDFOS DK A/S  
Martin Bachs Vej 3  
DK-8850 Bjerringbro  
Tlf.: +45-87 50 50 50  
Telefax: +45-87 50 51 51  
E-mail: info\_GDK@grundfos.com  
www.grundfos.com/DK

**Estonia**

GRUNDFOS Pumps Eesti OÜ  
Peterburi tee 92G  
11415 Tallinn  
Tel: + 372 606 1690  
Fax: + 372 606 1691

**Finland**

OY GRUNDFOS Pumpat AB  
Trukkikuja 1  
FI-01360 Vantaa  
Phone: +358-(0) 207 889 500

**France**

Pompes GRUNDFOS Distribution S.A.  
Parc d'Activités de Chesnes  
57, rue de Malacombe  
F-38290 St. Quentin Fallavier (Lyon)  
Tél.: +33-4 74 82 15 15  
Télécopie: +33-4 74 94 10 51

**Germany**

GRUNDFOS GMBH  
Schlüterstr. 33  
40699 Erkrath  
Tel.: +49-(0) 211 929 69-0  
Telefax: +49-(0) 211 929 69-3799  
e-mail: infoservice@grundfos.de  
Service in Deutschland:  
e-mail: kundendienst@grundfos.de

**Greece**

GRUNDFOS Hellas A.E.B.E.  
20th km. Athinon-Markopoulou Av.  
P.O. Box 71  
GR-19002 Peania  
Phone: +0030-210-66 83 400  
Telefax: +0030-210-66 46 273

**Hong Kong**

GRUNDFOS Pumps (Hong Kong) Ltd.  
Unit 1, Ground floor  
Siu Wai Industrial Centre  
29-33 Wing Hong Street &  
68 King Lam Street, Cheung Sha Wan  
Kowloon  
Phone: +852-27861706 / 27861741  
Telefax: +852-27858664

**Hungary**

GRUNDFOS Hungária Kft.  
Park u. 8  
H-2045 Törökbálint,  
Phone: +36-23 511 110  
Telefax: +36-23 511 111

**India**

GRUNDFOS Pumps India Private Limited  
118 Old Mahabalipuram Road  
Thoraiakkam  
Chennai 600 096  
Phone: +91-44 2496 6800

**Indonesia**

PT. GRUNDFOS POMPA  
Graha Intirub Lt. 2 & 3  
Jln. Cililitan Besar No.454. Makasar,  
Jakarta Timur  
ID-Jakarta 13650  
Phone: +62 21-469-51900  
Telefax: +62 21-460 6910 / 460 6901

**Ireland**

GRUNDFOS (Ireland) Ltd.  
Unit A, Merrywell Business Park  
Ballymount Road Lower  
Dublin 12  
Phone: +353-1-4089 800  
Telefax: +353-1-4089 830

**Italy**

GRUNDFOS Pompe Italia S.r.l.  
Via Gran Sasso 4  
I-20060 Truccazzano (Milano)  
Tel.: +39-02-95838112  
Telefax: +39-02-95309290 / 95838461

**Japan**

GRUNDFOS Pumps K.K.  
1-2-3, Shin-Miyakoda, Kita-ku,  
Hamamatsu  
431-2103 Japan  
Phone: +81 53 428 4760  
Telefax: +81 53 428 5005

**Korea**

GRUNDFOS Pumps Korea Ltd.  
6th Floor, Aju Building 679-5  
Yeoksam-dong, Kangnam-ku, 135-916  
Seoul, Korea  
Phone: +82-2-5317 600  
Telefax: +82-2-5633 725

**Latvia**

SIA GRUNDFOS Pumps Latvia  
Deglava biznesa centrs  
Augusta Deglava ielā 60, LV-1035, Rīga,  
Tālr.: + 371 714 9640, 7 149 641  
Fakss: + 371 914 9646

**Lithuania**

GRUNDFOS Pumps UAB  
Smolensko g. 6  
LT-03201 Vilnius  
Tel: + 370 52 395 430  
Fax: + 370 52 395 431

**Malaysia**

GRUNDFOS Pumps Sdn. Bhd.  
7 Jalan Peguam U1/25  
Glenmarie Industrial Park  
40150 Shah Alam  
Selangor  
Phone: +60-3-5569 2922  
Telefax: +60-3-5569 2866

**Mexico**

Bombas GRUNDFOS de México S.A. de  
C.V.  
Boulevard TLC No. 15  
Parque Industrial Stiva Aeropuerto  
Apodaca, N.L. 66600  
Phone: +52-81-8144 4000  
Telefax: +52-81-8144 4010

**Netherlands**

GRUNDFOS Netherlands  
Veluwezoom 35  
1326 AE Almere  
Postbus 22015  
1302 CA ALMERE  
Tel.: +31-88-478 6336  
Telefax: +31-88-478 6332  
E-mail: info\_gnl@grundfos.com

**New Zealand**

GRUNDFOS Pumps NZ Ltd.  
17 Beatrice Tinsley Crescent  
North Harbour Industrial Estate  
Albany, Auckland  
Phone: +64-9-415 3240  
Telefax: +64-9-415 3250

**Norway**

GRUNDFOS Pumper A/S  
Strømsveien 344  
Postboks 235, Leirdal  
N-1011 Oslo  
Tlf.: +47-22 90 47 00  
Telefax: +47-22 32 21 50

**Poland**

GRUNDFOS Pompy Sp. z o.o.  
ul. Klonowa 23  
Baranowo k. Poznania  
PL-62-081 Przeźmierowo  
Tel: (+48-61) 650 13 00  
Fax: (+48-61) 650 13 50

**Portugal**

Bombas GRUNDFOS Portugal, S.A.  
Rua Calvet de Magalhães, 241  
Apartado 1079  
P-2770-153 Paço de Arcos  
Tel.: +351-21-440 76 00  
Telefax: +351-21-440 76 90

**Romania**

GRUNDFOS Pompe România SRL  
Bd. Biruintei, nr 103  
Pantelimon county Ilfov  
Phone: +40 21 200 4100  
Telefax: +40 21 200 4101  
E-mail: romania@grundfos.ro

**Russia**

ООО Грундфос Россия  
Shkolnaya, 39-41  
Москва, RU-109544, Russia  
Тел. (+7) 495 564-88-00 (495) 737-30-00  
Факс (+7) 495 564 88 11  
E-mail grundfos.moscow@grundfos.com

**Serbia**

Grundfos Srbija d.o.o.  
Omladinskih brigada 90b  
11070 Novi Beograd  
Phone: +381 11 2258 740  
Telefax: +381 11 2281 769  
www.rs.grundfos.com

**Singapore**

GRUNDFOS (Singapore) Pte. Ltd.  
25 Jalan Tukang  
Singapore 619264  
Phone: +65-6681 9688  
Telefax: +65-6681 9689

**Slovakia**

GRUNDFOS s.r.o.  
Prievozská 4D  
821 09 BRATISLAVA  
Phona: +421 2 5020 1426  
sk.grundfos.com

**Slovenia**

GRUNDFOS LJUBLJANA, d.o.o.  
Leskoškova 9e, 1122 Ljubljana  
Phone: +386 (0) 1 568 06 10  
Telefax: +386 (0)1 568 06 19  
E-mail: tehnika-si@grundfos.com

**South Africa**

GRUNDFOS (PTY) LTD  
Corner Mountjoy and George Allen Roads  
Wilbart Ext. 2  
Bedfordview 2008  
Phone: (+27) 11 579 4800  
Fax: (+27) 11 455 6066  
E-mail: Ismart@grundfos.com

**Spain**

Bombas GRUNDFOS España S.A.  
Camino de la Fuentequilla, s/n  
E-28110 Algete (Madrid)  
Tel.: +34-91-848 8800  
Telefax: +34-91-628 0465

**Sweden**

GRUNDFOS AB  
Box 333 (Lunnagårdsgatan 6)  
431 24 Mölndal  
Tel.: +46 31 332 23 000  
Telefax: +46 31 331 94 60

**Switzerland**

GRUNDFOS Pumpen AG  
Bruggacherstrasse 10  
CH-8117 Fällanden/ZH  
Tel.: +41-44-806 8111  
Telefax: +41-44-806 8115

**Taiwan**

GRUNDFOS Pumps (Taiwan) Ltd.  
7 Floor, 219 Min-Chuan Road  
Taichung, Taiwan, R.O.C.  
Phone: +886-4-2305 0868  
Telefax: +886-4-2305 0878

**Thailand**

GRUNDFOS (Thailand) Ltd.  
92 Chaloen Phrakiat Rama 9 Road,  
Dokmai, Pravej, Bangkok 10250  
Phone: +66-2-725 8999  
Telefax: +66-2-725 8998

**Turkey**

GRUNDFOS POMPA San. ve Tic. Ltd. Sti.  
Gebze Organize Sanayi Bölgesi  
İhsan dede Caddesi,  
2. yol 200. Sokak No. 204  
41490 Gebze/ Kocaeli  
Phone: +90 - 262-679 7979  
Telefax: +90 - 262-679 7905  
E-mail: satis@grundfos.com

**Ukraine**

Бізнес Центр Європа  
Столичне шосе, 103  
М. Київ, 03131, Україна  
Телефон: (+38 044) 237 04 00  
Факс.: (+38 044) 237 04 01  
E-mail: ukraine@grundfos.com

**United Arab Emirates**

GRUNDFOS Gulf Distribution  
P.O. Box 16768  
Jebel Ali Free Zone  
Dubai  
Phone: +971 4 8815 166  
Telefax: +971 4 8815 136

**United Kingdom**

GRUNDFOS Pumps Ltd.  
Grovebury Road  
Leighton Buzzard/Beds. LU7 4TL  
Phone: +44-1525-850000  
Telefax: +44-1525-850011

**U.S.A.**

GRUNDFOS Pumps Corporation  
17100 West 118th Terrace  
Olathe, Kansas 66061  
Phone: +1-913-227-3400  
Telefax: +1-913-227-3500

**Uzbekistan**

Grundfos Tashkent, Uzbekistan The Repre-  
sentative Office of Grundfos Kazakhstan in  
Uzbekistan  
38a, Oybek street, Tashkent  
Телефон: (+998) 71 150 3290 / 71 150  
3291  
Факс: (+998) 71 150 3292

Addresses Revised 07.06.2017

<b>98491894</b> 0517
----------------------

ECM: 1173360
--------------